

Forelite: Working For Your Lights!

Factory address: Floor 5, Longjing Industry Building, Huashan Town, 510600 Huadu District, Guangzhou, P. R. China
Tel: +86 139 2887 9675
Wechat&WhatsApp: +86 139 2887 9675
Email: info@forelite.com
Homepage: <http://www.forelite.com>

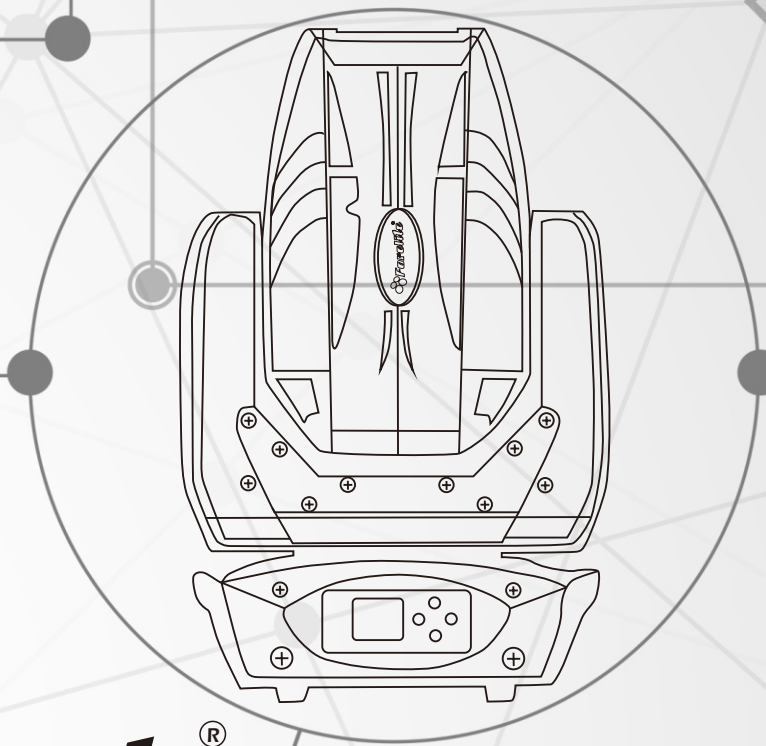

www.forelite.com



A BOUT US

Guangzhou Forelite Lighting Technology Co., Limited has been established since 2012. The factory is Located in Guangzhou of China, very near the Baiyun International Airport. We have more than 1000sqm workshop, around 30 workers.

Forelite Lighting Technology is a fast growing stage lighting manufacturer, which combines the R&D, manufacturing, sales and technical service. The high quality products are guaranteed by the self-developed mechanical design and program, advanced R&D lab, Electronics workshop, Assembling workshop and Q/A department and the cooperation with the high-quality material suppliers.

We have a high efficient sales and service team, which is able to provide you a fast and accurate service before and after the sales.

It's our R&D concept to focus on the developing of characteristic, valuable and innovative products; Customer-oriented and long-term cooperation is our sales and service concept.

In the past five years, we are one of the earliest beam moving head manufacturers in China and one of the biggest beam moving head suppliers. Our beam moving head has been the industrial model and used in all applications in China and more than 60 countries all over the world.

In 2014, we launched the most advanced LED product LED Matrix Moving Head Light, which has get very good feedback.

Continual innovation is our know-how of fast growing. In 2016, we will launch a series of advanced new products. We are expecting to cooperate with the customers and highlight your great show!

Focus on Art Work



Hubei TV Station



Zhejiang University Auditorium



Laos Night Bar



London Olympic Games



HCM Concert



Thailand Outdoor Performance



Korea Night Club



Jinan Televison



Vietnam Dance Club



Jinghu Movie Theater

Create
Max. Value for Clients

CONTENT

Page 01-08
LED Moving Head Light Series

Page 09-14
Battery LED Light Series

Page 15-18
Moving Head Light Series

Page 19-22
Matrix Blinder Light Series

Page 23-24
LED Wall Wash Light Series

Page 25-35
LED Par Light Series

Page 36-39
Controller Series

Page 40
Accessories

CERTIFICATE

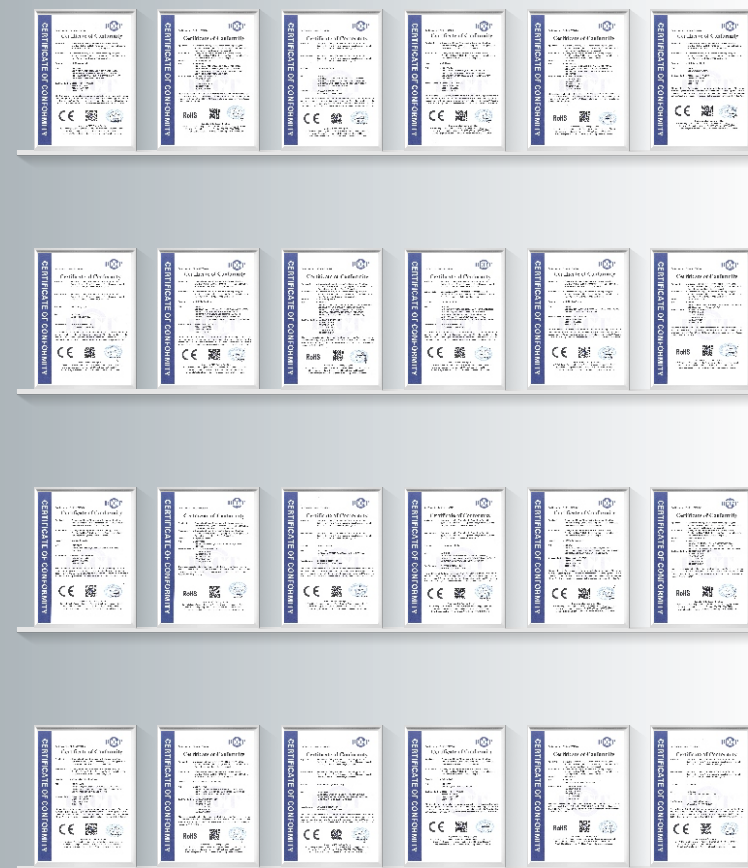



12pcs 40W LED Zoom Bee Eye Wash Moving Head

FO-BY1240Z

Specification	
Light sources	12pcs 40W RGBW 4in1 LED lamps
Input power	AC90-240V, 50/60Hz
Power	500W
X/Y	540°/270°
Life span of LED	50000h
Zoom angle	7-60°
Dimmer	0-100% linear dimmer
Control panel	1.77 in LED display+5 buttons
DMX channel	14CH, 17CH, 63CH
Working temp.	-25+45°C
Cooling system	High quality mute fans
Control mode	DMX512/Master-slave/Auto-run/Sound active/RDM
IP rating	IP 20
Accessories	Hanging bridge, power cable, signal cable
Net weight	11kg
Body size	312Dx235Wx357Hmm



Big Eye LED Moving Head Light (Zoom and Rotation)

FO-BY1915Z

Specification	
Light sources	19pcs RGBW 15W 4in1 OSRAM LED lamps
Input power	AC90-240V, 50/60Hz
Power	450W
X/Y	540°/250°
Life span of LED	50000h
Zoom angle	4-60°
Dimmer	0-100% linear dimmer
Control panel	Touch screen display+4 buttons
DMX channel	23CH/21CH/78CH/97CH/99CH DMX modes optional(built-in)
Working temp.	-25+45°C
Cooling system	High quality mute fans
Control mode	DMX512/Master-slave/Auto-run/Sound active
IP rating	IP 20
Accessories	Hanging bridge, power cable, signal cable
Net weight	11kg
Housing materials	ABS



Beehive LED Moving Head Wash Light

K20

Specification	
Light sources	12pcs 40W RGBW 4in1 LED lamps
Input power	AC90-240V, 50/60Hz
Power	500W
X/Y	540°/270°
Life span of LED	50000h
Zoom angle	7-60°
Dimmer	0-100% linear dimmer
Control panel	1.77 in LED display+5 buttons
DMX channel	14CH, 17CH, 63CH
Working temp.	-25+45°C
Cooling system	High quality mute fans
Control mode	DMX512/Master-slave/Auto-run/Sound active/RDM
IP rating	IP 20
Accessories	Hanging bridge, power cable, signal cable
Net weight	11kg
Body size	312Dx235Wx357Hmm



Beehive LED Moving Head Wash Light

K10

Specification	
Light sources	19pcs RGBW 15W 4in1 OSRAM LED lamps
Input power	AC90-240V, 50/60Hz
Power	450W
X/Y	540°/250°
Life span of LED	50000h
Zoom angle	4-60°
Dimmer	0-100% linear dimmer
Control panel	Touch screen display+4 buttons
DMX channel	23CH/21CH/78CH/97CH/99CH DMX modes optional(built-in)
Working temp.	-25+45°C
Cooling system	High quality mute fans
Control mode	DMX512/Master-slave/Auto-run/Sound active
IP rating	IP 20
Accessories	Hanging bridge, power cable, signal cable
Net weight	11kg
Housing materials	ABS

LED Moving Head Light Series



Specification	
Light sources	200W High Output white 8000K COB LED lamp
Input power	AC90-240V, 50/60Hz
Related power	260W
Light output	25200lux@4m, 7°, 3260lux@4m, 21°
Life span of LED	50000h
Zoom angle	11°-24°
Dimmer	0-100% linear dimmer
Control panel	LCD display+4 buttons
DMX channel	6CH, 18CH
Working temp.	-25+45°C
Cooling system	High quality mute fans
Control mode	DMX512/Master-slave/Auto-run/Sound active
IP rating	IP 20
Accessories	Hanging bridge, power cable, signal cable
Net weight	12.5kg
Body size	393Dx183Wx447Hmm

200W LED Moving Head Spot Light
FO-LM230C



18CH	1	2	3	4	5	6	7	8	9	10	11	12	13	14	15	16	17	18
%	Pan	Pan fine	Tilt	Tilt fine	Pan/Tilt Speed	Dimmer	Strobe	Color wheel	Gobo wheel	Rotating gobo	Rotating prism	Focus	Zoom	Prism	Prism rotation	Auto play	Auto X/Y	Reset

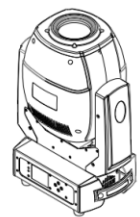
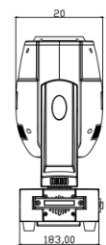
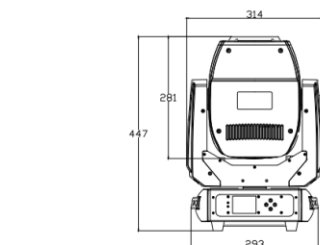

12.5kg(27.56lb)

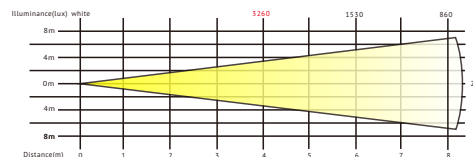
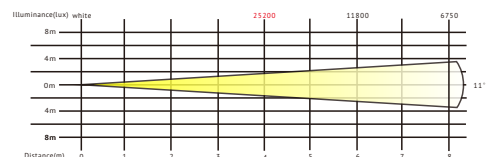

200W 3in1 Spot Beam Wash Moving Head
FO-LM200C

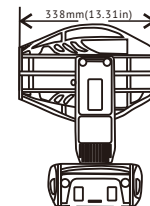
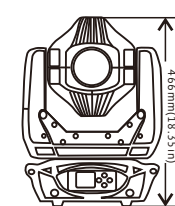
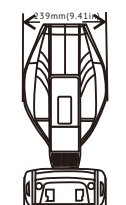
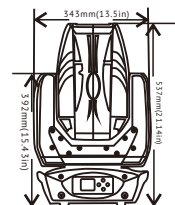

15.5kg(34.17lb)

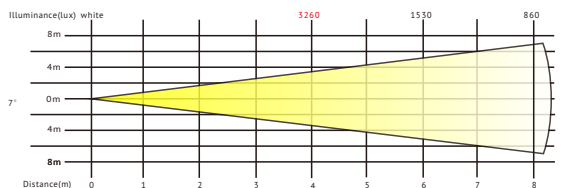
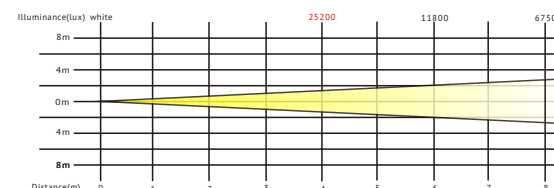

LED Moving Head Light Series



Specification	
Light sources	200W High Output white 7500K COB LED lamp
Input power	AC90-240V, 50/60Hz
Power	300W
Light output	25200lux@4m, 7°, 3260lux@4m, 21°
Life span of LED	50000h
Zoom angle	7-21°
Dimmer	0-100% linear dimmer
Control panel	LCD display+4 buttons
DMX channel	18CH
Working temp.	-25+45°C
Cooling system	High quality mute fans
Control mode	DMX512/Master-slave/Auto-run/Sound active
IP rating	IP 20
Accessories	Hanging bridge, power cable, signal cable
Net weight	15.5kg
Body size	343Dx239Wx537Hmm

18CH	1	2	3	4	5	6	7	8	9	10	11	12	13	14	15	16	17	18
%	Pan	Pan fine	Tilt	Tilt fine	Pan/Tilt Speed	Dimmer	Strobe	Color wheel	Gobo wheel	Rotating gobo	Rotating prism	Prism	Prism rotation	Frost	Focus	Zoom	Macro	Reset

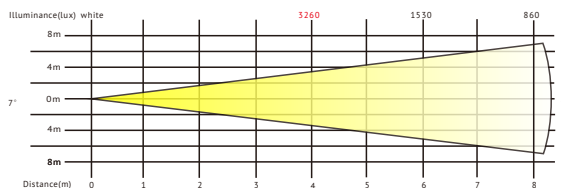
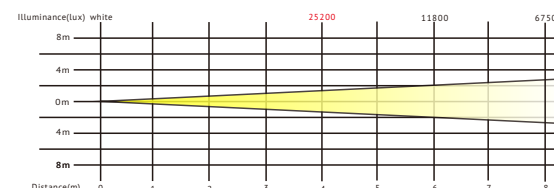

LED Moving Head Light Series



90W Spot LED Moving Head Light

FO-LM90CS

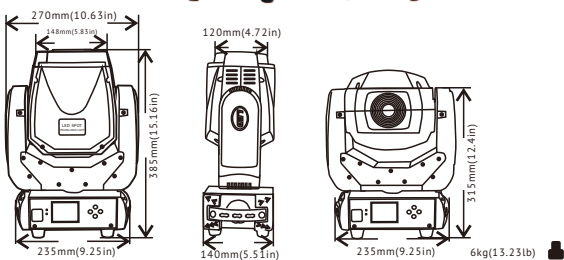

Specification	
Light sources	90W High Output white COE LED lamp
Input power	AC90-240V, 50/60Hz
Power	150W
Light output	3510lux@4m, white color
Life span of LED	50000h
Beam angle	15degree, with focus function
Dimmer	0-100% linear dimmer
Control panel	LCD display+4 buttons
DMX channel	6/16CH
Working temp.	-25-+45°C
Cooling system	High quality mute fans
Control mode	DMX512/Master-slave/Auto-run/Sound active
IP rating	IP 20
Accessories	Hanging bridge, power cable, signal cable
Net weight	6kg
Body size	235*140*385mm

16CH	1	2	3	4	5	6	7	8	9	10	11	12	13	14	15	16
%	Pan	Pan fine	Tilt	Tilt fine	Pan/Tilt Speed	Dimmer	Strobe	Color wheel	Static gobo wheel	Rotating gobo wheel	Rotating gobo rotation	Focus	Prism	Auto Program	XY Auto run	RESET
100%	0	0	0	0	normal	0	0	0	0	0	0	0	0	0	0	RESET
0%	0	0	0	0	random	0	0	0	0	0	0	0	0	0	0	RESET

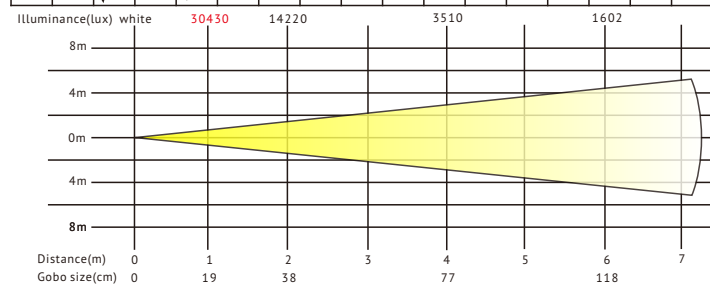

LED Moving Head Light Series



4x32W Infinite Rotating DJ Moving Head Light

FO-4HS432R

Specification	
Light sources	4pcs 32W RGBW 4in1 brightness LED lamps
Input power	AC90-240V, 50/60Hz
Power	150W
Beam angle	8degree
Control mode	DMX-512; Master/slave; Demo; Sound active
Control panel	LCD display + 4 buttons
Projection distance	4-30m
Pan/tilt	540(infinite)/180degree
DMX channel	2/16/32CH
Dimmer	0-100% linear dimmer
Cooling system	High quality mute fans
Strobe	1-25time/s
IP rating	IP 20
Accessories	Hanging bridge, power cable, signal cable
Net weight	9kg
Body size	485*310*320mm

Specification

Light sources	5pcs 40W RGBW 4in1 LEDs +250pcs 0.2W white LED
Input power	AC90-240V, 50/60Hz
Power	290W
Life span of LED	50000h
Dimmer	0-100% linear dimmer
Control panel	LCD display+4 buttons
DMX channel	13CH, 22CH, 37CH
Pan&tilt	Unlimited rotation, X/Y 360° infinite rotation
Fuse	F5AL250V.
Working temp.	-25-+45°C
Cooling system	High quality mute fans
Control mode	DMX512/Master-slave/Auto-run/Sound active
IP rating	IP 20
Accessories	Hanging bridge, power cable, signal cable
Net weight	11kg
Body size	515*180*282mm



Double Sides Spot Strobe DJ Moving Club Light

Forelle 540D

LED Moving Head Light Series



Specification	
Light sources	4pcs 32W RGBW 4in1 brightness LED lamps
Input power	AC90-240V, 50/60Hz
Power	150W
Beam angle	8degree
Control mode	DMX-512; Master/slave; Demo; Sound active
Control panel	LCD display + 4 buttons
Projection distance	4-30m
Pan/tilt	540/270degree
DMX channel	6/10/19/32/56CH
Dimmer	0-100% linear dimmer
Cooling system	High quality mute fans
Strobe	1-25time/s
IP rating	IP 20
Accessories	Hanging bridge, power cable, signal cable
Net weight	11kg
Body size	1000*260*90mm



4x32W RGBW Beam Spot DJ Moving Head Light

FO-4HS432D

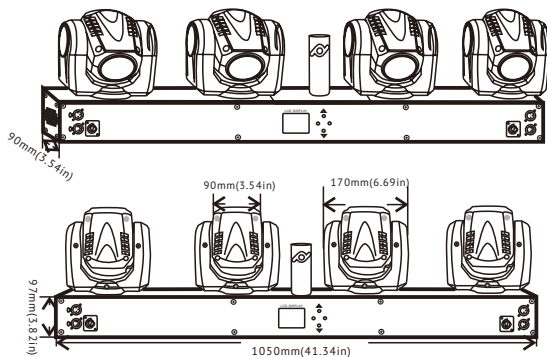

11kg(24.25lb)

10CH	1	2	3	4	5	6	7	8	9	10
%	Pan	Tilt	Dimmer	Strobe	Function	Speed	Color	Color chasing	Pan fine	Tilt fine
100% 255										
0%										

10CH Mode of VG-4HS432D, and 6/19/32/56CH can be used

LED Moving Head Light Series



Specification		
Light sources	12pcs 40W RGBW 4 in 1 LED	12pcs 40W RGBW 4 in 1 LED
Input power	AC90-240V, 50/60Hz	AC90-240V, 50/60Hz
Power	500W	250W
Shell material	aluminum	aluminum
Life span of LED	50000h	50000h
Zoom angle	5.5-45°	5.5-45°
Dimmer	0-100% linear dimmer	0-100% linear dimmer
Control panel	LCD display+4 buttons	LCD display+4 buttons
DMX channel	52CH, 16CH, 64CH, 21CH	14CH, 15CH, 27CH, 39CH
Working temp.	-25-+45°C	-25-+45°C
Cooling system	High quality mute fans	High quality mute fans
Control mode	DMX512/Master-slave/Auto-run	DMX512/Master-slave/Auto-run
IP rating	IP 20	IP 20
Accessories	Hanging bridge, power cable, signal cable	Hanging bridge, power cable, signal cable
Net weight	10.5kg	8.5kg
Body size	1050*180*350mm	670*180*350mm



40W 4in1 Moving Head Beam Dyeing Lights

FO-LM1240BAR FO-LM640BAR

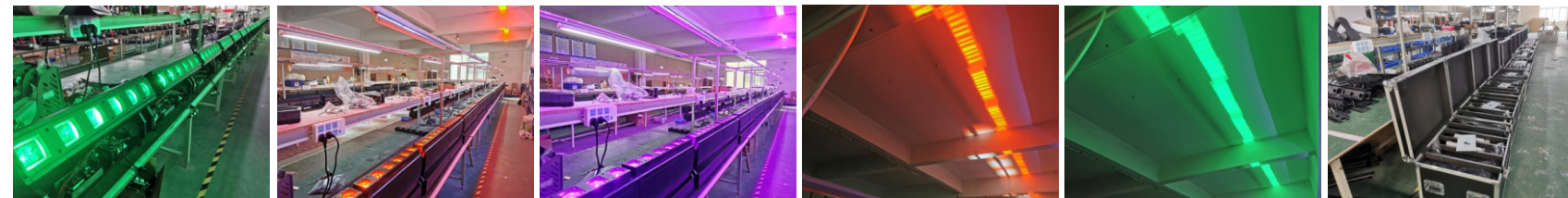
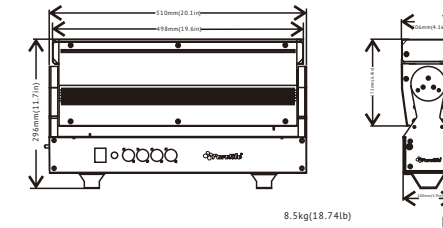
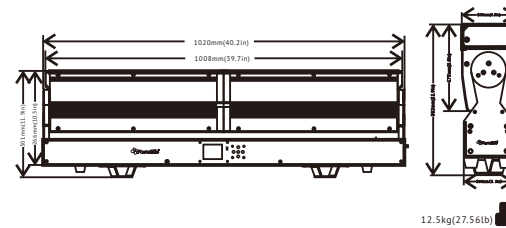



4pcs 18W RGBWAUV 6in1 LED Battery Wall Wash Light
FO-BLC418H

Specification	
Light sources	4pcs 6in1 RGBWAUV LED lamps
Input power	AC90-240V, 50/60Hz
Power	80W
Color	6in1 color mixing
Life span of LED	50000h
Beam angle	25°
Dimmer	0-100% linear dimmer
Control panel	LCD display+4 buttons
DMX channel	6CH, 10CH
Working temp.	-25-+45°C
Cooling system	Fanless
Control mode	DMX512/Master-slave/Auto-run/RDM
IP rating	IP 65
Accessories	Power cable, signal cable



6pcs 18W RGBWAUV 6in1 LED Battery Wall Wash Light
FO-BLC618H

Specification	
Light sources	6pcs 6in1 RGBWAUV LED lamps
Input power	AC90-240V, 50/60Hz
Power	110W
Color	6in1 color mixing
Life span of LED	50000h
Beam angle	25°
Dimmer	0-100% linear dimmer
Control panel	LCD display+4 buttons
DMX channel	6CH, 10CH
Working temp.	-25-+45°C
Cooling system	Fanless
Control mode	DMX512/Master-slave/Auto-run/RDM
IP rating	IP 65
Accessories	Power cable, signal cable



9pcs 18W 6in1 LED Battery Par Light
FO-BLP918H-N

Specification	
Light sources	9pcs 18W RGBWAUV 6in1 LED lamps
Input power	AC90-240V, 50/60Hz
Power	170W
Battery	Imported 18650 lithium battery * 18 3 series 6 and 9*2400=14400 capacity
Lifespan of battery	Charging and discharging can reach more than 500 times
Beam angle	25°(15/45° optional)
Dimmer	0-100% linear dimmer
Control panel	LCD display+4 buttons
DMX channel	6CH, 10CH
Working temp.	-25-+45°C
Cooling system	Fanless
Control mode	DMX512/Master-slave/Auto-run/Wifi/2.4Ghz wireless
IP rating	IP 20
Accessories	Power cable, signal cable



9pcs 18W 6in1 LED Battery Par Light
FO-BLP918H

Specification	
Light sources	9pcs 18W RGBWAUV 6in1 LED lamps
Input power	AC90-240V, 50/60Hz
Power	170W
Battery	Imported 18650 lithium battery * 18 3 series 6 and 9*2400=14400 capacity
Lifespan of battery	Charging and discharging can reach more than 500 times
Beam angle	25°(15/45° optional)
Dimmer	0-100% linear dimmer
Control panel	LCD display+4 buttons
DMX channel	6CH, 10CH
Working temp.	-25-+45°C
Cooling system	Fanless
Control mode	DMX512/Master-slave/Auto-run/Wifi/2.4Ghz wireless
IP rating	IP 20
Accessories	Power cable, signal cable



Specification	
Light sources	6pcs 18W RGBWAUV 6in1 LED lamps
Input power	AC90-240V, 50/60Hz
Power	110W
Battery	Imported 18650 lithium battery * 18 3 series 6 and 9*2400=14400 capacity
Lifespan of battery	Charging and discharging can reach more than 500 times
Beam angle	25°(15/45° optional)
Dimmer	0-100% linear dimmer
Control panel	LCD display+4 buttons
DMX channel	6CH, 10CH
Working temp.	-25-+45°C
Cooling system	Fanless
Control mode	DMX512/Master-slave/Auto-run/Wifi/2.4Ghz wireless
IP rating	IP 20
Accessories	Power cable, signal cable

6pcs 18W RGBWAUV 6in1 LED Battery Wall Wash Light

FO-BLP618H



Specification	
Light sources	6pcs 15W RGBWA 5in1 LED lamps
Input power	AC90-240V, 50/60Hz
Power	95W
Battery	Imported 18650 lithium battery * 18 3 series 6 and 9*2400=14400 capacity
Lifespan of battery	Charging and discharging can reach more than 500 times
Beam angle	25°(15/45° optional)
Dimmer	0-100% linear dimmer
Control panel	LCD display+4 buttons
DMX channel	5CH, 9CH
Working temp.	-25-+45°C
Cooling system	Fanless
Control mode	DMX512/Master-slave/Auto-run/Wifi/2.4Ghz wireless
IP rating	IP 20
Accessories	Power cable, signal cable

6pcs 15W RGBWA 5in1 LED Battery Wall Wash Light

FO-BLC615G



Specification	
Light sources	4pcs 18W RGBWAUV 6in1/15W 5in1 LED lamps
Input power	AC90-240V, 50/60Hz
Power	75W/62W
Battery	Imported 18650 lithium battery * 18 3 series 6 and 9*2400=14400 capacity
Lifespan of battery	Charging and discharging can reach more than 500 times
Beam angle	25°(15/45° optional)
Dimmer	0-100% linear dimmer
Control panel	LCD display+4 buttons
DMX channel	6CH, 10CH/5CH, 9CH
Working temp.	-25-+45°C
Cooling system	Fanless
Control mode	DMX512/Master-slave/Auto-run/Wifi/2.4Ghz wireless
IP rating	IP 20
Accessories	Power cable, signal cable

4pcs 18W 6in1 LED Battery Par Light

FO-BLP418H/FO-BLP415G



Specification	
Light sources	6pcs 15W RGBW4in1 LED Lamps
Input power	AC90-240V, 50/60Hz
Power	150W
Battery	Imported 18650 lithium battery * 18 3 series 6 and 9*2400=14400 capacity
Lifespan of battery	Charging and discharging can reach more than 500 times
Beam angle	40°
Dimmer	0-100% linear dimmer
Control panel	LCD display+4 buttons
DMX channel	6CH, 10CH
Working temp.	-25-+45°C
Cooling system	have fan
Control mode	DMX512/Master-slave/Auto-run/Wifi/2.4Ghz wireless
IP rating	IP 65
Accessories	Power cable, signal cable

Colorful LED Pillar for Celebration

FO-CLP001



6 Heads Battery Pin Spot Bar Light
FO-BPS60W

Specification	
Light sources	6 10W High Brightness LED Beads Imported Kohler XPE lamp beads
Input power	AC90-240V, 50/60Hz
Power	65W
Battery	18650 lithium battery *9 section 3 string 6 and 3*2400=14400 capacity
Lifespan of battery	Charging and discharging can reach more than 500 times
Beam angle	6-15° adjustable
Dimmer	0-100% linear dimmer
Control panel	Digital tube+4 buttons
DMX channel	2CH
Working temp.	-25-+45°C
Cooling system	Fanless
Control mode	DMX512/Master-slave/Auto-run/Wifi/2.4Ghz wireless
IP rating	IP 20
Accessories	Power cable, signal cable



10W LED Battery Pin Spot Light
FO-BPS10W-A

Specification	
Light sources	10W High Brightness LED Beads Imported Kohler XPE lamp beads
Input power	AC90-240V, 50/60Hz
Power	10W
Battery	Imported 18650 lithium battery * 18 3 series 6 and 9*2400=14400 capacity
Lifespan of battery	Charging and discharging can reach more than 500 times
Beam angle	6-8°adjustable
Dimmer	0-100% linear dimmer
Control panel	remoter
Color	2700K-2900K (color can be customized according to customers)
Working temp.	-25-+45°C
Cooling system	Fanless
Control mode	Remote
IP rating	IP 20
Accessories	Power adapter



10W LED Battery Pin Spot Light
FO-BPS10W

Specification	
Light sources	10W High Brightness LED Beads Imported Kohler XPE lamp beads
Input power	AC90-240V, 50/60Hz
Power	10W
Battery	Imported 18650 lithium battery * 18 3 series 6 and 9*2400=14400 capacity
Lifespan of battery	Charging and discharging can reach more than 500 times
Beam angle	6-8°adjustable
Dimmer	0-100% linear dimmer
Control panel	remoter
Color	2700K-2900K (color can be customized according to customers)
Working temp.	-25-+45°C
Cooling system	Fanless
Control mode	Remote
IP rating	IP 20
Accessories	Power adapter



12W Battery Pin Spot Light
FO-BPS12W

Specification	
Light sources	12W High Brightness LED Beads Imported Kohler XPE lamp beads
Input power	AC90-240V, 50/60Hz
Power	12W
Battery	imported 18650 lithium battery * 4 2 series 2 parallel 2*3000=6000 capacity
Lifespan of battery	Charging and discharging can reach more than 500 times
Beam angle	6-8°adjustable
Dimmer	0-100% linear dimmer
Control panel	remoter
Color	2700K-2900K (color can be customized according to customers)
Working temp.	-25-+45°C
Cooling system	Fanless
Control mode	Remote
IP rating	IP 20
Accessories	Power adapter

Moving Head Light Series



380W 3in1 Spot Beam Wash Moving Head

FO-MH380

Specification	
Light sources	YODN 380W U18 lamp
Input power	AC90-240V, 50/60Hz
Power	510W
Life span of lamp	2200h
Color wheel	13 colors + white
Gobo wheel	7 rotation gobos+white, 11 fixed gobos+white
Control panel	LCD display + 4 buttons
DMX channel	16CH/24CH
Prism	25and 16 facets circular rotating prism
Dimmer	0-100% linear dimmer
Strobe	1-25time/s
Zoom angle	2.5-65degree
Accessories	Hanging bridge, power cable, signal cable
Net weight	17kg
Body size	410*310*625mm



330W/260 Supper Beam Moving Head

FO-MH330A/FO-MH260A

Specification	FO-MH330A	FO-MH260A
Light sources	330W lamp	260W lamp
Input power	AC90-240V, 50/60Hz	AC90-240V, 50/60Hz
Power	350W	280W
Life span of lamp	2200h	2200h
Pan	540degree(16bit)	540degree(16bit)
Tilt	270degree(16bit)	270degree(16bit)
Control panel	LCD display + 4 buttons	LCD display + 4 buttons
DMX channel	18CH	18CH
Projection dist.	5-100m	5-100m
Dimmer	0-100% linear dimmer	0-100% linear dimmer
Strobe	1-25time/s	1-25time/s
Zoom angle	2degree	2degree
Accessories	Hanging bridge, cables	Hanging bridge, cables
Net weight	15kg	15kg
Body size	330*230*590mm	330*230*590mm

Battery LED Light Series



350W 3in1 Spot Beam Wash Moving Head

FO-MH350A

Specification	
Light sources	350W 17R lamp
Input power	AC90-240V, 50/60Hz
Power	550W
Life span of lamp	2000h
Color wheel	13 colors + white
Gobo wheel	12 rotation gobos, 17 fixed gobos, with gobo rotation function
Control panel	LCD display + 4 buttons
DMX channel	16CH/24CH
Prism	1pc 12-prism
Dimmer	0-100% linear dimmer
Strobe	1-25time/s
Zoom angle	2.5-42degree
Accessories	Hanging bridge, power cable, signal cable
Net weight	17kg
Body size	380*240*590mm

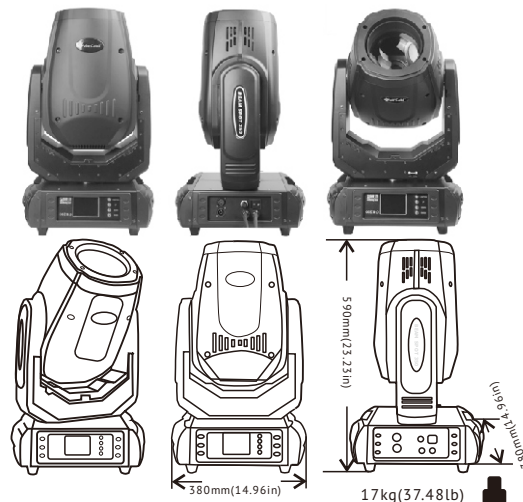

24CH	1	2	3	4	5	6	7	8	9	10	11	12	13	14	15	16	17	18	19	20	21	22	23	24	
%	Pan	Pan Fine	Tilt	Tilt fine	Pan/Tilt Speed	Macro	Color wheel	Half color	Gobo 2 speed	Gobo wheel 1	Gobo wheel 2	Rotating gobo	Rotating gobo fine	Prism	Prism rotation	Frost	Zoom	Zoom fine	Focus	Focus fine	Auto focus	Strobe	Dimmer	Blank	
100% 0%	⬅️ ➡️	⬅️ ➡️	⬆️ ⬆️	⬆️ ⬆️	normal backed backed backed	Macro	🌈	🌈	🔍	🌀	🌀	🌀	🌀	🔺	🔺	☁️	🔍	🔍	🔍	🔍	🔍	🔍	🔍	🔍	🔍
100% 0%	⬅️ ➡️	⬅️ ➡️	⬆️ ⬆️	⬆️ ⬆️	normal backed backed backed	Macro	🌈	🌈	🔍	🌀	🌀	🌀	🌀	🔺	🔺	☁️	🔍	🔍	🔍	🔍	🔍	🔍	🔍	🔍	🔍
100% 0%	⬅️ ➡️	⬅️ ➡️	⬆️ ⬆️	⬆️ ⬆️	normal backed backed backed	Macro	🌈	🌈	🔍	🌀	🌀	🌀	🌀	🔺	🔺	☁️	🔍	🔍	🔍	🔍	🔍	🔍	🔍	🔍	🔍

Moving Head Light Series



Specification

Light sources	280W 10R lamp
Input power	AC90-240V, 50/60Hz
Power	450W
Life span of lamp	2000h
Color wheel	13 colors + white
Gobo wheel	9 rotation gobos, 14 fixed gobos, with gobo rotation function
Control panel	LCD display + 4 buttons
DMX channel	17CH/24CH
Prism	1pc 12-prism
Dimmer	0-100% linear dimmer
Strobe	1-25time/s
Zoom angle	8.7-23degree
Accessories	Hanging bridge, power cable, signal cable
Net weight	18.5kg
Body size	380*240*590mm



10R 280W 3in1 Spot Beam Wash Moving Head

FO-MH280A

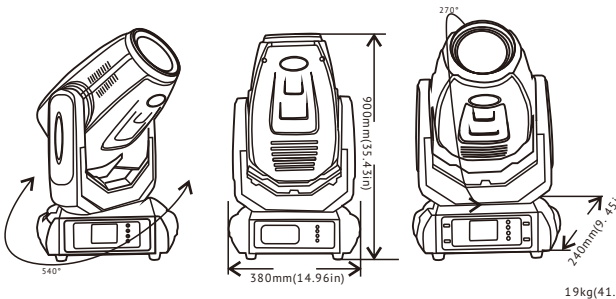

24CH	1	2	3	4	5	6	7	8	9	10	11	12	13	14	15	16	17	18	19	20	21	22	23	24
%	Pan	Pan fine	Tilt	Tilt fine	Tilt/Fine Speed	Macro	Color wheel	Color fine adjust	Gobo wheel select	Static gobo wheel	Rotating gobo wheel	Rotating gobo wheel adjust	Blank	Prism	Prism rotation	Frost	Zoom	Zoom fine	Focus	Focus fine	No function	Strobe	Dimmer	No function

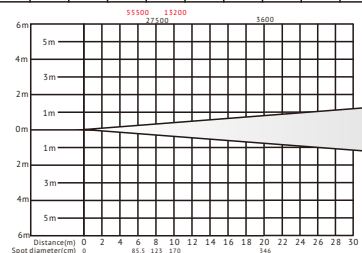
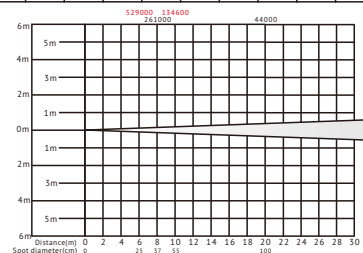

Battery LED Light Series



Specification

Light sources	230W 7R lamp
Input power	AC90-240V, 50/60Hz
Power	300W
Life span of lamp	2000h
Color wheel	14 colors + white
Gobo wheel	17 fixed gobos, with gobo rotation function
Control panel	LCD display + 4 buttons
DMX channel	16CH
Prism	1pc 16-prism
Dimmer	0-100% linear dimmer
Strobe	1-25time/s
Beam angle	0-3.8degree
Accessories	Hanging bridge, power cable, signal cable
Net weight	17kg
Body size	364*410*520mm



7R 230W Beam Sharpy Moving Head Light

FO-MH230A

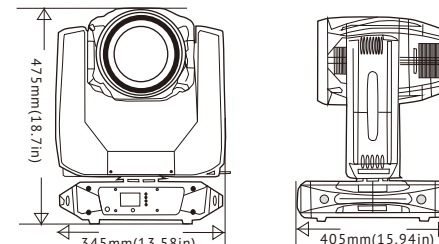

16CH	1	2	3	4	5	6	7	8	9	10	11	12	13	14	15	16
%	Color wheel	Strobe	Dimmer	Gobo wheel	Prism	Prism rotation	Macro	Frost	Focus	Pan	Pan fine	Tilt	Tilt fine	No function	Reset	Lamp on/off

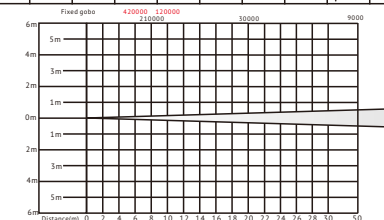

Matrix Blinder Light Series



25 Eyes RGBW 4in1 LED Matrix Blinder Light

FO-MSL425D

Specification	
Light sources	25pcs 12W RGBW 4-in-1 COM LED lamps, (Golden/Cool white)
Input power	AC90-240V, 50/60Hz
Power	350W
Color	RGBW colorful mixing
Life span of LED	50000h
Beam angle	25°
Dimmer	0-100% linear dimmer
Control panel	Digital tube+4 buttons
DMX channel	1, 4, 5, 25, 75, 100CH
Working temp.	-25+45°C
Cooling system	High quality mute fans
Control mode	DMX512/Master-slave/Auto-run/Sound active
IP rating	IP 20
Accessories	Power cable, signal cable, handle
Net weight	13kg
Body size	580Dx580Wx120Hmm

Specification	
Light sources	25pcs 10W RGB 3in1 LED lamps
Input power	AC90-240V, 50/60Hz
Power	300W
Color	RGB 3in1/Golden white/Cool white
Life span of LED	50000h
Beam angle	30degree
Dimmer	0-100% linear dimmer
Control panel	Digital tube+4 buttons
DMX channel	1, 3, 5, 25, 75CH
Working temp.	-25+45°C
Material of shell	Steel
Control mode	DMX512/Master-slave/Auto-run/Sound active
IP rating	IP 20
Accessories	Power cable, signal cable, handler
Net weight	13kg
Body size	580*580*120mm

25 Eyes RGB 3in1 LED Matrix Blinder Light

FO-MSL025



Matrix Blinder Light Series



16 Eyes 30W 3in1 LED Matrix Blinder Light

FO-MSL016B

Specification	
Light sources	16pcs 30W RGB 3in1 LED lamps, (Golden/Cool white optional)
Input power	AC90-240V, 50/60Hz
Power	500W
Color	RGB 3in1 colorful mixing
Life span of LED	50000h
Beam angle	25°
Dimmer	0-100% linear dimmer
Control panel	Digital tube+4 buttons
DMX channel	3, 4, 6, 16, 18, 48, 49, 50, 51CH
Working temp.	-25+45°C
Cooling system	High quality mute fans
Control mode	DMX512/Master-slave/Auto-run/Sound active
IP rating	IP 20
Accessories	Power cable, signal cable, connection spare parts
Net weight	11kg
Body size	470Dx470Wx130Hmm

Specification	
Light sources	5pcs 30W RGB 3in1 LED lamps, (Golden/Cool white optional)
Input power	AC90-240V, 50/60Hz
Power	150W
Color	RGB 3in1 colorful mixing
Life span of LED	50000h
Beam angle	30°
Dimmer	0-100% linear dimmer
Control panel	Digital tube+4 buttons
DMX channel	1, 3, 5, 7, 15, 18CH
Working temp.	-25+45°C
Cooling system	High quality mute fans
Control mode	DMX512/Master-slave/Auto-run/Sound active
IP rating	IP 20
Accessories	Power cable, signal cable
Net weight	3.5kg
Body size	620Dx160Wx150Hmm

5 Eyes 30W RGB 3in1 LED Matrix Blinder Light

FO-MSL530C

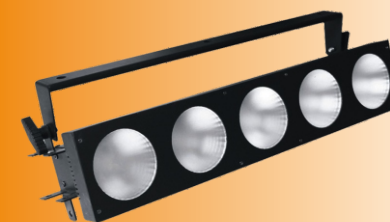

Matrix Blinder Light Series



Specification	
Light sources	25pcs 75W golden lamp
Input power	AC220V, 50/60Hz
Power	1900W
Color	Golden white
Life span of lamp	2000h
Beam angle	30°
Dimmer	0-100% linear dimmer
Control panel	Digital tube+4 buttons
DMX channel	3, 8, 25, 28CH
Working temp.	-25+45°C
Cooling system	High quality mute fans
Control mode	DMX512/Master-slave/Auto-run/Sound active
IP rating	IP 20
Accessories	Power cable, signal cable, handle(chargeable)
Net weight	21kg
Body size	575Dx575Wx200Hmm

25 Eyes 75W Golden Matrix Blinder Light

FO-MS025



Specification	
Light sources	5pcs 75W golden lamp
Input power	AC220V, 50/60Hz
Power	380W
Color	Golden white
Life span of lamp	2000h
Beam angle	30°
Dimmer	0-100% linear dimmer
Control panel	Digital tube+4 buttons
DMX channel	3, 8, 5CH
Working temp.	-25+45°C
Cooling system	High quality mute fans
Control mode	DMX512/Master-slave/Auto-run/Sound active
IP rating	IP 20
Accessories	Power cable, signal cable, hanging handle/connection parts (chargeable)
Net weight	5kg
Body size	580Dx115Wx150Hmm

5 Eyes 75W Golden Matrix Blinder Light

FO-MS005

Matrix Blinder Light Series



Specification	
Light sources	100W COB LED lamp (warm white/cool white/bi color)
Input power	AC100-240V, 50/60Hz
Power	450W
Quantity of LED	4pcs 100W COB warm white LED lamps
Life span of LED	50000h
Beam angle	45degree
Dimmer	0-100% linear dimmer
Control panel	digital tube display+4 buttons
DMX channel	1/2/4/8CH
Working temp.	-25+45°C
Cooling system	High quality radiator, fan without noise
Control mode	DMX512/Demo/Manual
IP rating	IP 20
Accessories	Handle, power cable, signal cable
Net weight	10.5kg
Body size	370*370*100mm

400W LED Audience Blinder Light

FO-COB4



8CH	1	2	3	4	5	6	7	8
%	Dimmer	Lamp 1 Dimmer	Lamp 2 Dimmer	Lamp 3 Dimmer	Lamp 4 Dimmer	Strobe	Function Choose	Function Speed
100% 255						random strobe	Sound active	Speed
0%						strobe close	Fade	Jump



18pcs 6in1 LED Wall Wash Light
FO-LC1818H/FO-LC1818H-S

Specification	(every lamp every color control solely)	
Product model	FO-LC1818H	FO-LC1818H-S
Light sources	18pcs 18W RGBWAUV 6in1 LED lamps	18pcs 18W RGBWAUV 6in1 LED lamps
Input power	AC90-240V, 50/60Hz	AC90-240V, 50/60Hz
Power	350W	350W
Beam angle	25°(15° optional)	25°(15° optional)
Color	RGBWAUV 6in1 color mixing	RGBWAUV 6in1 color mixing
Lifespan	50000h	50000h
Dimmer	0-100% linear dimmer	0-100% linear dimmer
Projection distance	3-10m	3-10m
Control mode	DMX-512; Auto run	DMX-512; Auto run
DMX channels	6CH, 10CH, 108CH, 112CH	6CH, 10CH
Strobe	1-20 times/second	1-20 times/second
IP rating	IP 65	IP 65
Housing materials	Aluminum die casting	Aluminum die casting
Accessories	Waterproof Power cable, signal cable	Waterproof Power cable, signal cable
Net weight	8kg	8kg
Dimension	1000*92*171mm	1000*92*171mm



24pcs 4in1 LED Wall Wash Light
FO-LC2410D

Specification	(every lamp every color control solely)	
Product model	FO-LC1810D	FO-LC1810D-S
Light sources	18pcs 12W RGBW 4in1 LED lamps	18pcs 12W RGBW 4in1 LED lamps
Input power	AC90-240V, 50/60Hz	AC90-240V, 50/60Hz
Power	200W	200W
Beam angle	15°	15°
Color	RGBW 4in1 color mixing	RGBW 4in1 color mixing
Lifespan	50000h	50000h
Dimmer	0-100% linear dimmer	0-100% linear dimmer
Projection distance	3-10m	3-10m
Control mode	DMX-512; Auto run	DMX-512; Auto run
DMX channels	32CH	8CH, 4CH
Strobe	1-20 times/second	1-20 times/second
IP rating	IP 65	IP 65
Housing materials	Aluminum die casting	Aluminum die casting
Accessories	Waterproof Power cable, signal cable	Waterproof Power cable, signal cable
Net weight	7.6kg	7.6kg
Dimension	1000*92*171mm	1000*92*171mm



24x3W 3in1 Outdoor LED Wall Wash Light
FO-LC243C

Specification	
Light sources	24pcs 3W RGB 3in1 LED lamps
Input power	AC90-240V, 50/60Hz
Power	100W
Life span	500,000h
Color	RGB 3in1 color mixing
Beam angle	25degree
Control panel	Digital tube + 4 buttons
DMX channel	7CH
Control mode	DMX-512; Master/slave mode; Demo mode
Dimmer	0-100% linear dimmer
Strobe	1-25time/s
Body material	Aluminum die casting
Accessories	Power cable, signal cable
IP rating	IP 65
Net weight	4kg
Body size	1020*80*120mm



High Power Outdoor LED City Color Light
FO-LC1203B

Specification	
Light sources	120pcs 3W RGBW LED Lamps (R: 30; G: 30; B: 30; W: 30)
Input power	AC90-240V, 50/60Hz
Power	400W
Life span	500,000h
Color	RGBW color mixing
Beam angle	25°(8°/15°/45°/60°optional)
Control panel	Digital tube + 4 buttons
DMX channel	7CH
Control mode	DMX-512; Master/slave mode; Demo mode
Dimmer	0-100% linear dimmer
Strobe	1-25time/s
Body material	Aluminum die casting
Accessories	Power cable, signal cable
IP rating	IP 65

Outdoor LED Par Light Series



18pcs 18W 6in1 Outdoor LED Par Light

FO-LP1818H

Specification	
Light sources	18pcs 18W 6in1 RGBWAUV LED lamp
Input power	AC90-240V, 50/60Hz
Power	350W
Light output	19380lux@2m, full light on
Life span of LED	50000h
Beam angle	25degree
Dimmer	0-100% linear dimmer
Control panel	Digital tube+4 buttons
DMX channel	6/10CH
Working temp.	-25-+45°C
Cooling system	Body natural heat dissipator
Control mode	DMX512/Master-slave/Auto-run/Sound active
IP rating	IP 65
Accessories	Power cable, signal cable
Net weight	5.5kg
Body size	260*330*350mm



Slim 18pcs 18W 6in1 Outdoor LED Par Light

FO-LP1818HS

Specification	
Light sources	18pcs 18W 6in1 RGBWAUV LED lamp
Input power	AC90-240V, 50/60Hz
Power	350W
Light output	19380lux@2m, full light on
Life span of LED	50000h
Beam angle	25degree
Dimmer	0-100% linear dimmer
Control panel	Digital tube+4 buttons
DMX channel	6/10CH
Working temp.	-25-+45°C
Cooling system	Body natural heat dissipator
Control mode	DMX512/Master-slave/Auto-run/Sound active
IP rating	IP 65
Accessories	Power cable, signal cable
Net weight	5.5kg
Body size	230*230*320mm



9pcs 18W Outdoor 6in1 LED Par Light

FO-LP918H

Outdoor LED Par Light Series



Specification	
Light sources	9pcs 18W 6in1 RGBWAUV LED lamp
Input power	AC90-240V, 50/60Hz
Power	185W
Light output	16000lux@1m, full light on
Life span of LED	50000h
Beam angle	30degree
Dimmer	0-100% linear dimmer
Control panel	Digital tube+4 buttons
DMX channel	6CH, 10CH
Working temp.	-25-+45°C
Cooling system	Body natural heat dissipator
Control mode	DMX512/Master-slave/Auto-run/Sound active
IP rating	IP 65
Accessories	Power cable, signal cable
Net weight	4.5kg
Body size	250*250*250mm



7pcs 12W Outdoor 4in1 LED Par Light

FO-LP712D

Specification	
Light sources	7pcs 12W 4in1 RGBW LED lamp
Input power	AC90-240V, 50/60Hz
Power	85W
Color	RGBW 4in1 color mixing
Life span of LED	50000h
Beam angle	25degree
Dimmer	0-100% linear dimmer
Control panel	Digital tube+4 buttons
DMX channel	5CH
Working temp.	-25-+45°C
Cooling system	Body natural heat dissipator
Control mode	DMX512/Master-slave/Auto-run/Sound active
IP rating	IP 65
Accessories	Power cable, signal cable
Net weight	2.5kg

Outdoor LED Par Light Series



54pcs 3W Outdoor LED Par Light
FO-LP543B

Specification	
Light sources	54pcs 3W RGBW LED lamps
Input power	AC90-240V, 50/60Hz
Power	170W
Life span	500,000h
Color	RGBW color mixing
Beam angle	25degree(45/60degree optional)
Control panel	Digital tube + 4 buttons
DMX channel	8CH
Control mode	DMX-512; Master/slave mode; Demo mode
Dimmer	0-100% linear dimmer
Strobe	1-25time/s
Body material	Aluminum die casting
Accessories	Power cable, signal cable
IP rating	IP 65
Net weight	9kg
Body size	350*290*290mm



9pcs 18W 6in1 Outdoor LED Par Light
FO-LP189H

Specification	
Light sources	9pcs 18W 6in1 RGBWAUV LED Lamps
Input power	AC90-240V, 50/60Hz
Power	130W
Life span	500,000h
Color	RGBWAUV color mixing
Beam angle	15°/25°/40° Optional
Control panel	Digital tube + 4 buttons
DMX channel	5CH, 9CH
Control mode	DMX-512; Master/slave mode; Demo mode
Dimmer	0-100% linear dimmer
Strobe	1-25time/s
Body material	Aluminum die casting
Accessories	Power cable, signal cable
IP rating	IP 65
Net weight	4.7kg
Body size	270*270*130mm

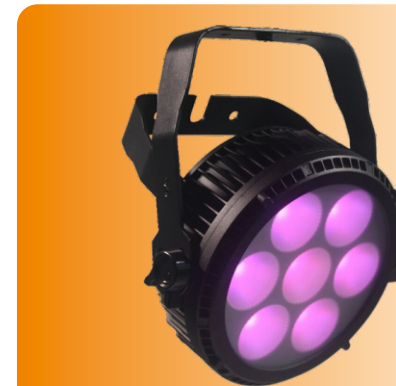

7pcs 25W 5in1 Outdoor LED Par Light
FO-LP725G

Outdoor LED Par Light Series



Specification	
Light sources	7pcs 25W RGBWA 5in1 LED Lamp
Input power	AC90-240V, 50/60Hz
Power	140W
Life span	500,000h
Color	RGBWA color mixing
Beam angle	20degree/30degree/60degree
Control panel	Digital tube + 4 buttons
DMX channel	5CH, 8CH
Control mode	DMX-512; Master/slave mode; Demo mode
Dimmer	0-100% linear dimmer
Strobe	1-25time/s
Body material	Aluminum die casting
Accessories	Power cable, signal cable
IP rating	IP 65
Net weight	6.2kg
Body size	270*256*145mm(without handle), 270*256*310mm(with handle)



200W Bi-color Outdoor COB Par Light
FO-LP200-B

Specification	
Light sources	1pc 200W COB warm white LED lamp
Input power	AC90-240V, 50/60Hz
Power	250W
Life span	500,000h
Color	golden white
Beam angle	30degree
Control panel	Digital tube + 4 buttons
DMX channel	5CH
Control mode	DMX-512; Master/slave mode; Demo mode
Dimmer	0-100% linear dimmer
Strobe	1-25time/s
Body material	Aluminum die casting
Accessories	Power cable, signal cable
IP rating	IP 65
Net weight	9.5kg
Body size	240*270*268mm

COB LED Par Light Series



200W Bi-color LED Par Light

FO-LPI200W-B

Specification	
Light sources	200W Bi Color COB LED lamp (100W 5600K+100W 3200K)
Input power	AC100-240V, 50/60Hz
Power	250W
Beam angle	120 degree
Life span of LED	50000h
Strobe	1-25time/s
Dimmer	0-100% linear dimmer
Control panel	digital tube display+4 buttons
DMX channel	4CH
Working temp.	-25-+45°C
Cooling system	High quality mute fan
Control mode	DMX512/Master-slave/Demc/Manual
IP rating	IP 20
Accessories	Handle, Barn doors, power cable, signal cable
Net weight	4kg
Body size	D253*W300*H210mm

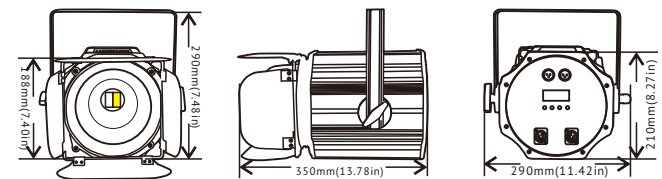

4kg(8.82lb)

4CH	1	2	3	4
%	Dimmer	5600K Dimmer	3200K Dimmer	Strobe
100%	255			random strobe
				pulse-effect in sequences
				strobe close

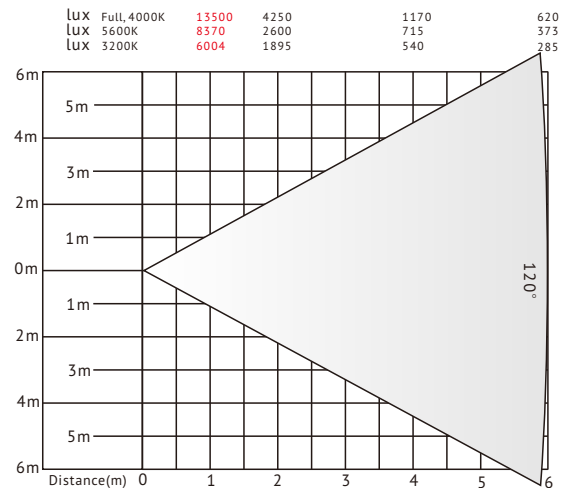

Outdoor LED Par Light Series



200W COB LED Par Light

FO-LPI200B

Specification	
Light sources	1pc 200W 3200K warm white/5600K cold white COB lamp
Input power	AC100-240V, 50/60Hz
Power	250W
Beam angle	half 45 degree
Life span of LED	50000h
Strobe	1-25time/s
Dimmer	0-100% linear dimmer
Control panel	digital tube display+4 buttons
DMX channel	2CH
Working temp.	-25-+45°C
Cooling system	High quality mute fan
Control mode	DMX512/Master-slave/Demc/Manual
IP rating	IP 20
Accessories	Handle, Barn doors, power cable, signal cable
Net weight	4.5kg
Body size	D350*W300*H295mm



100W COB LED Par Light

FO-LPI100

Specification	
Light sources	1pc 100W warm white/cold white COB lamp
Input power	AC100-240V, 50/60Hz
Power	150W
Beam angle	120 degree
Life span of LED	50000h
Strobe	1-25time/s
Dimmer	0-100% linear dimmer
Control panel	digital tube display+4 buttons
DMX channel	2CH
Working temp.	-25-+45°C
Cooling system	High quality mute fan
Control mode	DMX512/Master-slave/Demc/Manual
IP rating	IP 20
Accessories	Handle, Barn doors, power cable, signal cable
Net weight	4kg
Body size	D220*W220*H230mm

COB LED Par Light Series



30W RGB 3in1 Party LED Par Light
FO-CP30

Specification	
Light sources	1pcs 30W RGB 3in1 COB lamp
Input power	AC100-240V, 50/60Hz
Power	40W
Beam angle	25degree(90degree optional)
Life span of LED	50000h
Strobe	1-25time/s
Dimmer	0-100% linear dimmer
Control panel	digital tube display+4 buttons
DMX channel	2CH, 3CH1, 3CH2, 6CH
Working temp.	-25+45°C
Cooling system	High quality mute fan
Control mode	DMX512/Master-slave/Demc/Manual
IP rating	IP 20
Accessories	Power cable, signal cable
Net weight	1.5kg
Body size	D200*W200*H150mm



4 Heads 30W RGB 3in1 Party LED Par Light
FO-CPS4

Specification	
Light sources	4pcs 30W RGB 3in1 COB lamp
Input power	AC100-240V, 50/60Hz
Power	160W
Beam angle	25degree(90degree optional)
Life span of LED	50000h
Strobe	1-25time/s
Dimmer	0-100% linear dimmer
Control panel	digital tube display+4 buttons
DMX channel	2CH, 3CH1, 3CH2, 6CH
Working temp.	-25+45°C
Cooling system	High quality mute fan
Control mode	DMX512/Master-slave/Demo/Manual
IP rating	IP 20
Accessories	Power cable, signal cable



18pcs 18W 6in1 Indoor LED Par Light
FO-LPI1818H

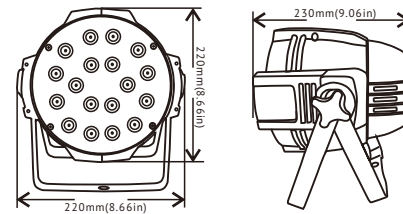

4.5kg(9.92lb)

Indoor LED Par Light Series



Specification	
Light sources	18pcs 15W 6in1 RGBWA-UV LED lamps
Input power	AC90-240V, 50/60Hz
Power	200W
Light output	19400lux@2m
Life span of LED	50000h
Zoom angle	25degree(8degree/15degree/45degree are optional)
Dimmer	0-100% linear dimmer
Control panel	Digital tube display+4 buttons
DMX channel	10CH, 6CH
Working temp.	-25+45°C
Cooling system	High quality mute fans
Control mode	DMX512/Master-slave/Auto-run/Sound active
IP rating	IP 20
Accessories	Handle, power cable, signal cable
Net weight	4.5kg
Body size	230Dx220Wx220Hmm

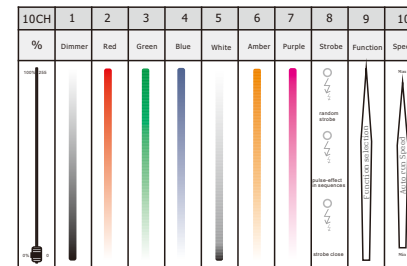

6CH and 10CH are optional

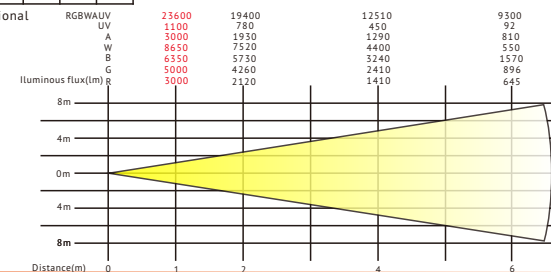

Indoor LED Par Light Series



18pcs 12W RGBW 4in1 LED Par Light

FO-LPI1812D

Specification	
Light sources	18pcs 12W 4in1 RGBW LED lamp
Input power	AC90-240V, 50/60Hz
Power	200W
Color	RGBW 4in1 color mixing
Life span of LED	50000h
Beam angle	25degree
Dimmer	0-100% linear dimmer
Control panel	Digital tube+4 buttons
DMX channel	8CH
Working temp.	-25-+45°C
Cooling system	Body natural heat dissipation+mute fan
Control mode	DMX512/Master-slave/Auto-run/ Sound active
IP rating	IP 20
Accessories	Power cable, signal cable
Net weight	7kg
Body size	260*330*350mm



54pcs 3W RGBW Indoor LED Par Light

FO-LPI543B

Specification	
Light sources	54pcs 3W RGBW LED lamps
Input power	AC90-240V, 50/60Hz
Power	170W
Life span	500,000h
Color	RGBW color mixing
Beam angle	25degree(45/60degree optional)
Control panel	Digital tube + 4 buttons
DMX channel	8CH
Control mode	DMX-512; Master/slave mode; Demo mode
Dimmer	0-100% linear dimmer
Strobe	1-25time/s
Body material	Aluminum die casting
Accessories	Power cable, signal cable
IP rating	IP 20



54pcs 3W RGBW Indoor LED Par Light

FO-LPI354B

Indoor LED Par Light Series



9pcs 12W 4in1 Flat LED Par Light

FO-FP912D

Specification	
Light sources	54pcs 3W RGBW LED lamps
Input power	AC90-240V, 50/60Hz
Power	170W
Life span	500,000h
Color	RGBW color mixing
Beam angle	25degree(45/60degree optional)
Control panel	Digital tube + 4 buttons
DMX channel	8CH
Control mode	DMX-512; Master/slave mode; Demo mode
Dimmer	0-100% linear dimmer
Strobe	1-25time/s
Body material	Aluminum die casting
Accessories	Power cable, signal cable
IP rating	IP 20

Specification	
Light sources	9pcs 12W 4in1 RGBW LED lamps
Input power	AC100-240V, 50/60Hz
Power	120W
Beam angle	25 degree
Life span of LED	50000h
Strobe	1-25time/s
Dimmer	0-100% linear dimmer
Control panel	digital tube display+4 buttons
DMX channel	7CH, 4CH
Working temp.	-25-+45°C
Cooling system	High quality mute fan
Control mode	DMX512/Master-slave/Demo/ Manual
IP rating	IP 20
Accessories	Power cable
Net weight	1.2kg
Body size	D180*W180*H50mm

Flat Indoor LED Par Light Series



6pcs 18W 6in1 Flat LED Par Light
FO-FP618H

Specification	
Light sources	6pcs 18W 6in1 RGBWAUV LED lamps
Input power	AC100-240V, 50/60Hz
Power	110W
Beam angle	25 degree
Life span of LED	50000h
Strobe	1-25time/s
Dimmer	0-100% linear dimmer
Control panel	digital tube display+4 buttons
DMX channel	7CH, 4CH
Working temp.	-25-+45°C
Cooling system	High quality mute fan
Control mode	DMX512/Master-slave/Demc/Manual
IP rating	IP 20
Accessories	Power cable
Net weight	1.2kg
Body size	D180*W180*H50mm



18pcs 3W RGB 3in1 Flat LED Par Light
FO-FP183C

Specification	
Light sources	18pcs 3W RGB 3in1 LED lamps
Input power	AC100-240V, 50/60Hz
Power	60W
Beam angle	25 degree
Life span of LED	50000h
Strobe	1-25time/s
Dimmer	0-100% linear dimmer
Control panel	digital tube display+4 buttons
DMX channel	6CH
Working temp.	-25-+45°C
Cooling system	High quality mute fan
Control mode	DMX512/Master-slave/Demc/Manual
IP rating	IP 20
Accessories	Power cable
Net weight	1.5kg



2048CH Hand Drawing DMX Console
FO-HD2048

Control System Series



Specification	
Total DMX channel	2048CH
Control lights	16CH 48 units; 32CH 16 units; 9CH 85 units
Scan library	no need scan library, patch by DMX channel chart of light
Hand draw program	can edit the hand draw pattern program, or choose the built-in pattern program, one pattern has four different vision, the edited pattern can be saved
Sound and light synchronization	effective
Audio and video synchronization	effective
User manual	built-in user manual
Button	have the explanation of every button
Feature 1	No need scan library, easily operate (efficient)
Feature 2	Unified editing the operation method and tools (convenient)
Feature 3	Single menu, operate over the panel directly (convenient)
Feature 4	Boot to use, no need set (convenient)
Feature 5	Intelligent hand programming (unique & efficient)



2048CH Tiger Touch DMX Console
Tiger Touch

Specification	
Total DMX channel	2048CH
Related power	AC110V/AC220V, 50/60Hz [Need confirm the input power]
Net weight	15kg
Shell color	white
Features	Offers all the Pearl features including Theatre Playback, Time code, MIDI triggers, etc;
Channels	2,048 channels to 240 moving lights on 4 isolated DMX outputs
Playback	10 playback sub-masters, expandable to 15 with external playback wing
Library	Full personality library in the console, with free updates on website
Spare parts	VGA screen, desk light and flight case are optional and chargeable



Black Horse DMX Console

MA Black Horse

Specification	
Level-Wheel	1
A/B fader (100mm)	2
Master fader (60mm)	1
Executor Faders (60mm)	21
USB connectors	4
Audio input	1
Stereo output	1
LTC input	1
DMX-512 outputs	6
DMX-512 input/output	1
MIDI output	1
MIDI input	1



Command Wing Console Panel

Command Wing

Specification	
Version	Ma2, 3.3.2.2
Package	Flight case
Flight case	69*51*20cm(1pcs/case)
N.W/G.W	13kg/16.5kg



Fade Wing Console

Fade Wing

Specification	
Version	Ma2, 3.3.2.2
Package	Flight case
Flight case	51*49*19cm(1pcs/case)
N.W/G.W	9kg/12.5kg



192CH DMX Console

FO-DC192

Specification	
Power supply	Electronic auto-ranging
Input voltage range	AC90-240V, 50/60Hz
Power consumption	3W
Console dimesion	480Dx140Wx65Hmm
Weight	1.5kg
Body material	steel
Total DMX channel	192CH
Signal output	3 pins or 5 pins



2nd Generation Sunlite Suite FC+
FO-Sunlite 2 FC+

Specification	
Version	sunlite 2, FC+
Built in scan library	2000 kinds different lights scan library from 100 manufacturers can be called
Edit scan library	you can edit the scan library based on the light fixtures user manual channel chart, each operating
Body dimension	D120*W950*H380mm
Net weight	0.15kg
Suitable computer system	win7 32 bit, win 7 64 bit
Software storage	EF card on the box



2.4G Wireless DMX Transmitter and Receiver
Wireless 2.4G

Specification	
Power	2.4G, powerful transmit and receive signal
Set	One set can be transmitter or receiver, you only need set on the panel
Feature	Save the DMX cable, easy operate, and convenient
Control	Wireless, transmit or receive the signal from DMX console
Power supply	Electronic auto-ranging
Input power	AC90-240V, 50/60Hz
Power consumption	6W
Dimension	130*100*50mm
Weight	1.5kg



Moving Head Light Rain Dome
FO-LC001



Moving Head Rain Dome
FO-LC002



Indoor Par Light Rain Dome
FO-LC004



Stage Light Clamps
FO-C1



Stage Light Clamps
FO-C2



Stage Light Clamps
FO-C8